

STEREO RECEIVER

KR-1000

INSTRUCTION MANUAL

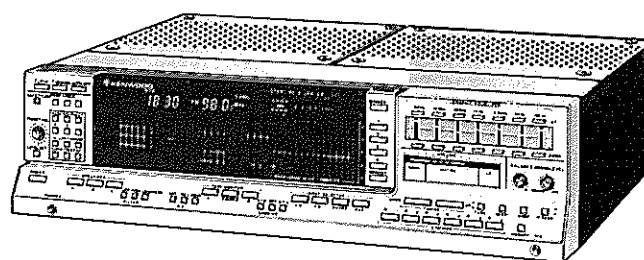

 **KENWOOD**

INTRODUCTION

The purpose of this manual is to acquaint you with the operating features of your new receiver. You will notice that in every detail of planning, engineering, styling, operating convenience, and adaptability, we have sought to anticipate your needs and desires.

We suggest that you read this manual carefully. Knowing how to set up your receiver to the best advantage will enhance your listening pleasure right from the start. You will also become aware of the ease with which you can adjust your receiver to meet your special requirements.

FOR YOUR RECORDS

Record the serial number, found on the back of the unit, in the spaces designated on the warranty card, and in the space provided below. Refer to the model and serial numbers whenever you call upon your Kenwood dealer for information or service on this product.

Model KR-1000 Serial number _____

UNPACKING

Unpack the unit carefully and make sure that all accessories and cables are put aside so they will not be lost.

Examine the unit for any possibility of shipping damage. If your unit is damaged or fails to operate, notify your dealer immediately. If your unit was shipped to you directly, notify the shipping company without delay. Only the consignee (the person or company receiving the unit) can file a claim against the carrier for shipping damage.

We recommend that you retain the original carton and packing materials for use should you transport or ship the unit in the future.

INSTALLATION PRECAUTIONS

- (a) Avoid locations subject to direct sunlight.
- (b) Avoid high or low temperature extremes.
- (c) Keep the unit away from heat radiating sources.
- (d) Choose a location that is relatively free of vibration or excessive dust.
- (e) Make sure power is off before making any system connections.

WARNING:

**TO PREVENT FIRE OR SHOCK HAZARD,
DO NOT EXPOSE THIS APPLIANCE TO
RAIN OR MOISTURE.**

IMPORTANT!

U.S.A.

Units shipped to the U.S.A. are designed for operation on 120 volts AC only. These units are not equipped with an AC Voltage Selector switches and the discussion of such switches that follow should be disregarded.

ALL OTHER COUNTRIES

Units shipped to countries other than the U.S.A. are equipped with an AC Voltage Selector switches on the rear panel. Refer to the following paragraph for the proper setting of these switches.

AC VOLTAGE SELECTION

This unit operates on AC 120V, 220V or 240V. The AC Voltage Selector Switches on the rear panel are set to the voltage that prevails in the area to which the unit is shipped. Before connecting the power cord to your AC outlet, make sure that the setting positions of these switches match your line voltage. If not, they must be set to your voltage in accordance with the following direction.

Note:

Our warranty does not cover damage caused by excessive line voltage due to improper setting of the AC Voltage Selector Switches.

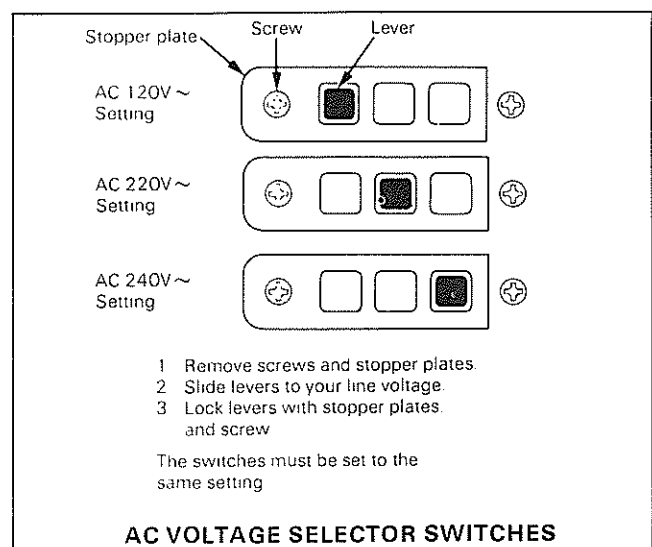

CONTENTS

SAFETY PRECAUTIONS.....	3	PRESETTING OPERATIONS	
SYSTEM CONNECTION DIAGRAM	4	(HOW TO SET THE CLOCK).....	16
SYSTEM CONNECTIONS.....	5	(HOW TO PRESET BROADCASTING	
CONTROLS, INDICATORS		STATIONS).....	17
AND CONNECTORS		(HOW TO DRAW SIGNAL	
(TIMER PROGRAMMING KEYBOARD).....	8	FLOWCHARTS)	18
(KEYBOARD FOR DRAWING		(HOW TO COMBINE SIGNAL FLOW-	
THE SIGNAL FLOWCHART).....	11	CHARTS AND PRESET STATION).....	19
(PROGRAM MODE COMMANDER		(TIMER PROGRAMMING).....	20
KEYBOARD).....	12	(AUTOMATIC SHUT-OFF SETTING)	27
(TUNER OPERATION KEYBOARD		OPERATING INSTRUCTIONS.....	29
AND PUSHBUTTONS).....	13	IN CASE OF DIFFICULTY	34
(OTHER FEATURES).....	14	SPECIFICATIONS.....	35
(DISPLAY).....	15		

SAFETY PRECAUTIONS

CLEANING

Do not use volatile solvents such as alcohol, paint thinner, gasoline, benzine, etc. to clean the cabinet. Use a silicone cloth or a clean dry cloth.

VENTILATION HOLES

The case top is slotted to allow ventilation. Never block these holes with ornamental cloths, books, or other objects. Make sure that metal objects such as coins, hairpins, or needles do not enter the unit through the ventilation holes. The result could be a serious malfunction or a possible shock hazard. Make sure that children do not insert foreign objects into the ventilation holes.

SERVICE OR MODIFICATIONS

Do not remove the cabinet or touch internal parts. Refer all service to qualified service personnel. Unauthorized modifications can result in a dangerous shock hazard and can void the warranty.

POWER CORD

Always insert or remove the power plug from the AC outlet by grasping the plug body. Never pull or stretch the cord. Take care that the cord is not subject to traffic or bent sharply around furniture. Keep heavy object off the cord; never route it under rugs, and avoid the use of extra extension cords. Attention to these precautions will avoid fire or shock hazards.

SYSTEM CONNECTION DIAGRAM

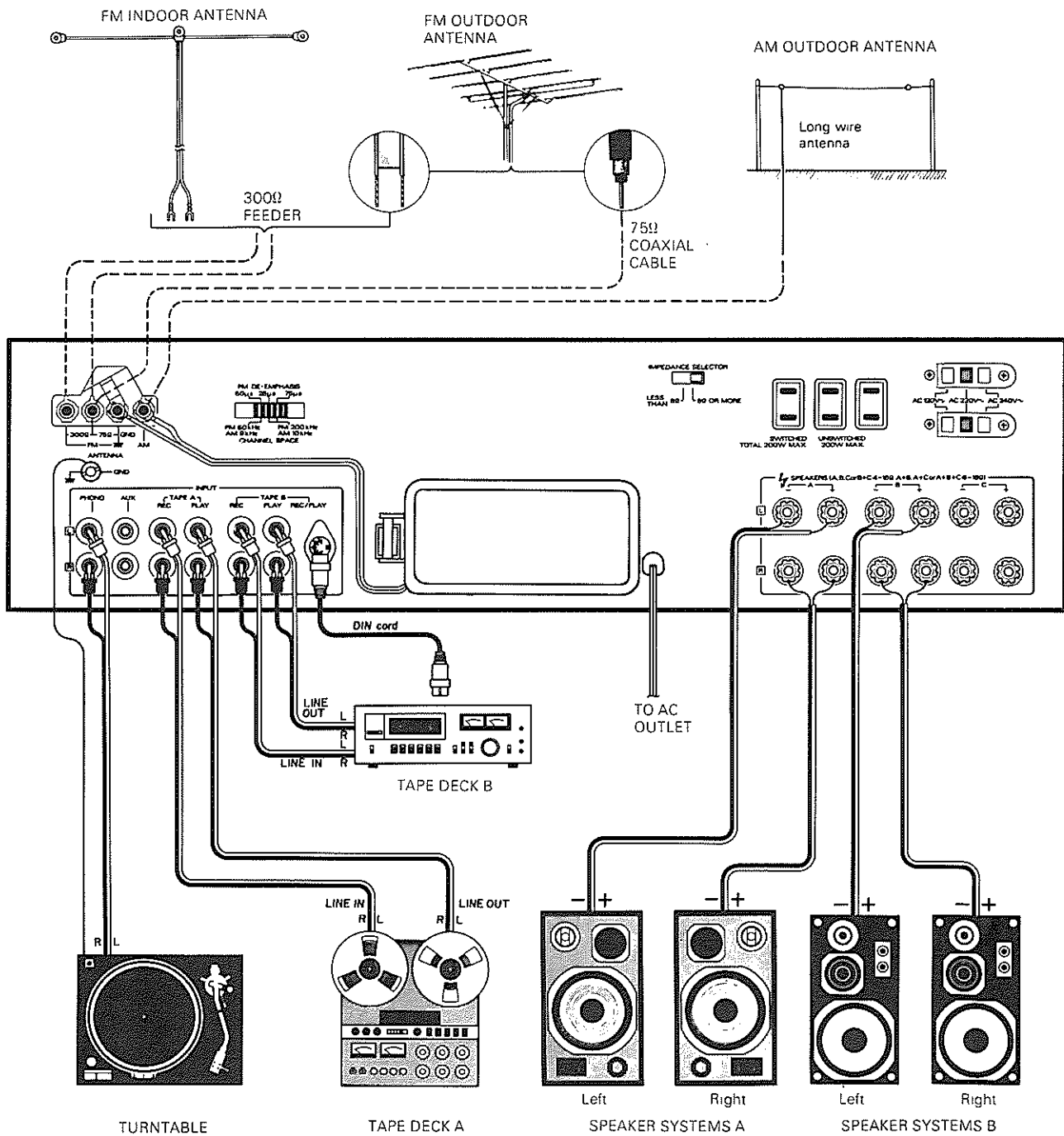

SYSTEM CONNECTIONS

SPEAKERS

If only one set of speakers is to be connected, make connections to the terminals marked SPEAKERS A, as shown on page 4. Connect the speakers to the **L** and **R** terminals in accordance with the location selected for each speaker. To ensure correct speaker phasing, observe polarity marks; connect terminals marked + on the receiver to similarly-marked speaker terminals. Do the same for receiver and speaker terminals marked with a minus sign. Reversal of speaker leads will result in loss of bass tones and poor stereo separation.

If a second set of speakers is to be used, make connections at the right set of terminals, marked B. A third set of speakers may be connected to the terminals marked C.

IMPEDANCE SELECTOR switch

This switch is factory set to the setting "**8Ω OR MORE**".

Use this setting when speakers are operated under the following conditions:

1. When a pair of speakers, each speaker rated at 8 ohms or more, is to be used.
2. When two pairs of speakers connected to the B and C terminals, each speaker rated at 4 ohms or more, are to be used in combination.

However, this switch must be switched to the setting "**LESS THAN 8Ω**" under the following conditions:

1. When a pair of speakers, each speaker rated less than 8 ohms, is to be used.
2. When two pairs of speakers connected to the A and B (or C) terminals are to be used in combination.
3. When three pairs of speakers connected to the A, B, and C terminals are to be used in combination.

WARNING!

Particular attention must be given to making good electrical contact at the receiver-output and speaker terminals. Poor or loose connections can cause sparking or burning at the terminals because of the very high power that the receiver can deliver.

Follow these steps carefully.

1. Strip 10 mm (3/8 inch) of insulation from the ends of the speaker cable. Twist the bare strands of wire together and solder the ends to keep the strands from separating.



2. Back the caps of the SPEAKER terminals on the receiver all the way out by turning them counterclockwise as far as they will go.
3. Insert one end of the cable into the hole in the + terminal as shown below.

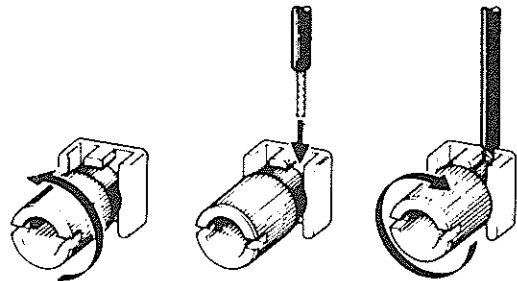

4. Turn the cap clockwise and tighten securely to ensure a firm contact.
5. Connections at your speakers will vary depending upon the type of terminals used. Check the manufacturer's instructions and make sure that a good, tight, metal-to-metal contact is made.
6. Check all connections. Make sure all are tight, and that there are no loose strands of wire touching the wrong terminals or the metal cabinet or trim.

TURNTABLES

Your stereo turntable has two audio cables that are terminated with phono plugs. Plug the left channel plug into the **L** and the right channel plug into the **R** PHONO INPUT jacks as shown on page 4.

AUX JACKS

INPUT AUX jacks are used to connect other high-level signal sources, such as tuners, extra tape decks (equipped with preamps), TV or VTR sound output mic preamps, etc.

TAPE DECKS

If only one tape deck is to be connected to the system it is recommended that it be connected to the jacks marked TAPE A.

Tape deck input and output cables are normally terminated with phono plugs.

Playback

Plug the left and right output cables of the tape deck into the **L** and **R** TAPE A PLAY jacks.

Record

Plug the left and right input cables of the tape deck into the **L** and **R** TAPE A REC jacks.

DIN connector

If your tape deck is equipped with a DIN connector, connect it to the TAPE B REC/PLAY connector with the DIN connecting cord. The DIN connection makes both input and output connections with a single cord, and the signal can be controlled with the TAPE MONITOR key marked B on the front panel.

Note: _____

If connections are made with a DIN connecting cord, the TAPE B PLAY and REC jacks should not be used.

Second tape deck

Plug the input and output cables from the second tape deck into the REC and PLAY jacks marked B.

AC OUTLETS

The AC outlets on the rear panel of the receiver may be used to supply power to other components such as a turntable, tape deck, etc.

1. SWITCHED OUTLETS

These outlets are controlled by the POWER switch and the Timer. (The total capacity is 200 watts maximum.)

2. UNSWITCHED OUTLET

This outlet delivers power at all times. (The capacity is 200 watts maximum.)

Note: _____

Never connect any equipment whose power consumption exceeds the capacity of each outlet.

FM ANTENNAS

Since FM broadcast signals travel along a straight, direct-line path, they become rather weak behind hills and buildings even in the vicinity of a broadcasting station. FM signals also become weak in areas distant from a station even though there may not be any obstruction to the direct-line path of the signal. Therefore, a good FM antenna should be installed in the most effective manner for best possible FM reception.

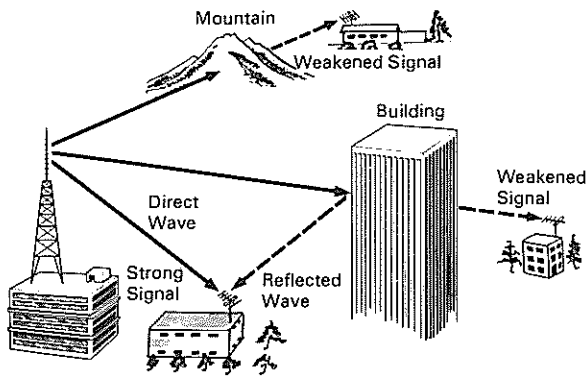

Direct Wave and Reflected Wave

FM Outdoor Antenna

In areas at a greater distance from the transmitting station, the use of an outdoor antenna is highly recommended. It is available in various types. For reception of stations located in many directions, a non-directional type antenna will offer better results. When using a directional antenna, always orient it for the best reception of the desired station. The correct position will be indicated by highest possible number of the SIGNAL LEDs on the unit.

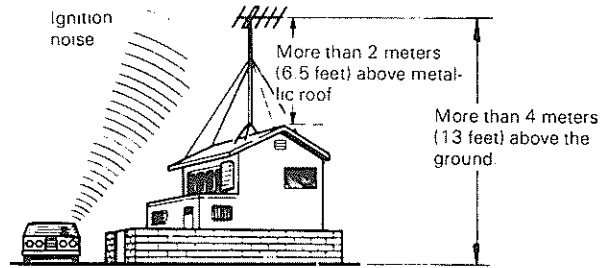

- To minimize auto-ignition noise, locate the antenna as far from heavy traffic as possible.
- Keep the feeder or coaxial cable as short as possible. Do not bundle or roll up excess cable.
- The antenna should be at least two meters (6.5 feet) from reinforced concrete walls, or metal structures.

FM Indoor Antenna

In areas close to the transmitting station, the supplied T-type antenna may suffice. Spread two arms of the antenna horizontally and position them for the best reception, listening to an FM station. The antenna can then be taped to a wall or ceiling and must not be rounded nor folded. It should be remembered, however, that the pickup of reflections (similar to "ghosts" on TV) will result in poor stereo reception. These reflections must be reduced to a minimum, either by careful orientation of the T-type antenna or, if this will not eliminate them, by using a more directional outdoor antenna.

CHANNEL SPACE/FM DE-EMPHASIS MUTUAL SWITCH

This switch on the rear panel is set to the correct setting that prevails in the area to which the unit is shipped.

However, if the CHANNEL SPACE setting is not matched to the area where the receiver is to be used; for instance, when you moved from area ① to area ② or vice-versa, desired reception of FM/AM broadcasts is not expected. In this case, change the CHANNEL SPACE setting in accordance with the area corresponding to the table shown below so that the FM DE-EMPHASIS setting is matched automatically.

Area	CHANNEL SPACE	FM DE-EMPHASIS
① U.S.A., Canada Hawaii, and Guam	FM: 200 kHz AM: 10 kHz	75 μ s
② European countries Far East countries	FM: 50 kHz AM: 9 kHz	50 μ s

Note:

The 25 μ s setting should be selected when this receiver is used with an auxiliary Dolby* NR adaptor to receive Dolby FM broadcasts.

* Dolby is the Trademark of Dolby Laboratories Licensing Corporation.

AM Outdoor Antenna

In concrete buildings or at a great distance from the transmitter, it may be necessary to install and outdoor wire antenna. The end of this wire should be stripped of insulation and connected to the AM terminal.

At this time, keep the loop antenna connected.

AM ANTENNAS

AM Loop Antenna

Tune to your favorite AM station and position the loop antenna for best reception. Try other stations and find the position that gives best overall reception.

When this unit is mounted in a rack or placed on a shelf with insufficient space behind, remove the loop antenna and hang it from a wall in the direction which gives best reception. If the length of the lead wire is too short, add a lead wire of an appropriate length.

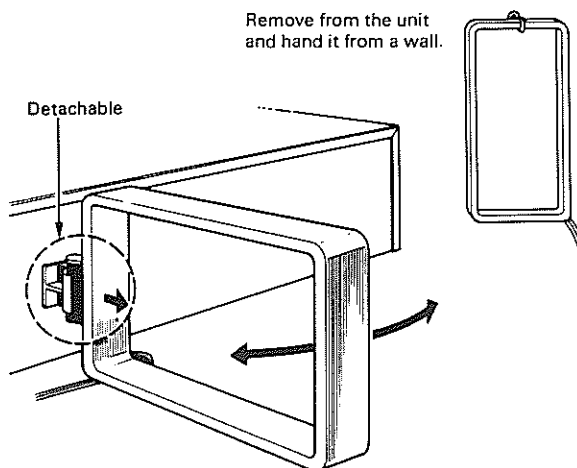

AM Loop Antenna Adjustment

CONTROLS, INDICATORS AND CONNECTORS

TIMER PROGRAMMING KEYBOARD

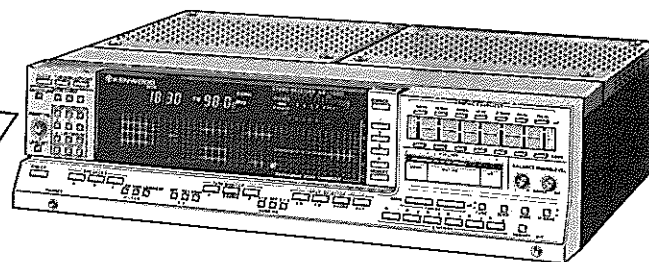
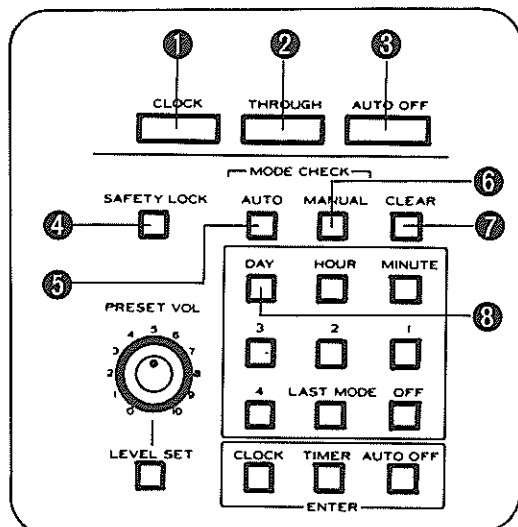

① CLOCK key

Once the display has been set to the standard time, you can refer to the current time by pressing this key with any timer display.

② THROUGH key

When this key is pressed, the timer-controlled operation is not executed. Press this key and the letters "THRU" will light at the left of the timer display. When executing timer-controlled operation, press any keys other than THROUGH and POWER keys to release the THROUGH function.

Note:

When you go out, first turn off the power and be sure to press the THROUGH key to stop the execution of the timer operations, observing the letters THRU lit in the timer display, or the timer operations may be executed while you are absent.

③ AUTO OFF key

Pressing this key causes the timer display to show the designated number of minutes and the letters "A-OFF" to the left of it. When the displayed number of minutes have elapsed, the power is automatically shut off. The present time is then displayed. You can set up to a maximum of 79 minutes. Each minute the display counts down to show the remaining minutes until the power will be shut off. For further details, see page 27

④ SAFETY LOCK key

To prevent the programs stored in the memory from being spoiled due to misoperation, press this key then the word "LOCKED" will light at the left of the timer display. When renewing the program, press this key again to release the lock function. The word "LOCKED" will then go out.

⑤ AUTO (MODE CHECK) key

When reviewing the programs stored in the memory or clearing them, press this key and they will be displayed automatically about every 5 minutes. When all the programs have been displayed, the current time is displayed again. The display repeats this cycle from the top of the memory. When the memory has no programs, the current time flashes about every 5 minutes. To stop this operation, press the CLOCK key.

⑥ MANUAL (MODE CHECK) key

Performs the same operation described in the preceding item. However, programs are displayed only when the key is pressed.

⑦ CLEAR key

Clears the programs called out by use of the AUTO/MANUAL (MODE CHECK) key. Each keystroke clears the program shown on the display and automatically calls up the following program.

⑧ DAY key

Sets the day of week for time setting or for timer-controlled programming. Each keystroke causes the display as shown below. When the key is held depressed, 2 ~ 3 seconds later the day advances at high speed.

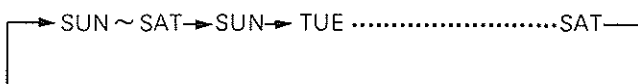

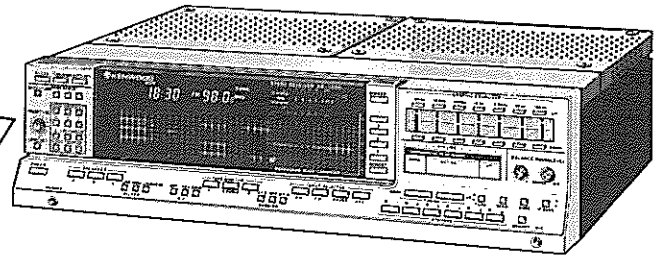
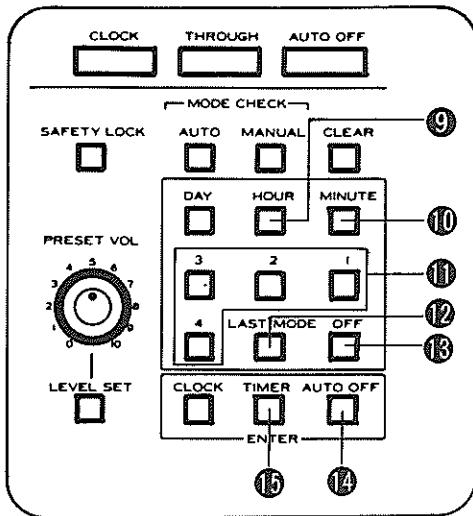

9 HOUR key

Sets the hour. Each keystroke increments the hour as shown in the figure below. When the key is held depressed, 2 ~ 3 seconds later the hour display advances at high speed.

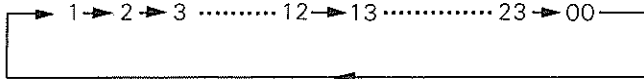

10 MINUTE key

Sets the minute. Each keystroke increments the minute as shown in the figure below. The key functions in the same way as described in the preceding item.

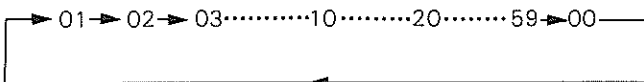

11 Keys marked 1, 2, 3 and 4

The keys marked 1, 2, 3 and 4 are interlocked with the PROGRAM MODE COMMANDER keys marked M-1, M-2, M-3 and M-4 respectively. When programming push one of these to define the desired program mode. When the programs are executed, the unit is turned on with the program mode designated or the current program mode is switched to another program mode at the designated time. For further details, see pages 22 and 23.

12 LAST MODE key

Defines the instruction which turns the unit on at the designated time with the same signal flowchart on the display that was there before the power was last turned off.

13 OFF key

Defines the instruction which turns the unit off at the designated time.

14 AUTO OFF (ENTER) key

Stores the auto shut-off instruction (minutes) designated by the MINUTE key into the memory. This will execute the instruction.

15 TIMER (ENTER) key

Stores the programs defined by the programming keys into the memory. Eight programs can be stored with this key. If you attempt to store a ninth program by pushing this key, the whole timer display indicating the program starts flashing to warn you that the memory is full.

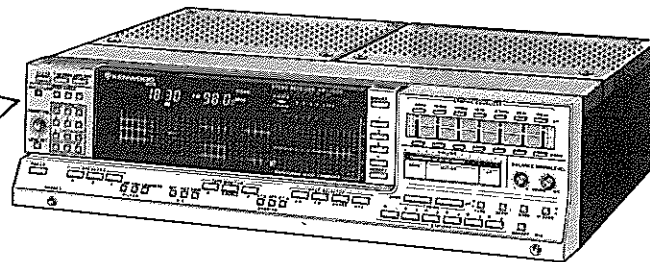
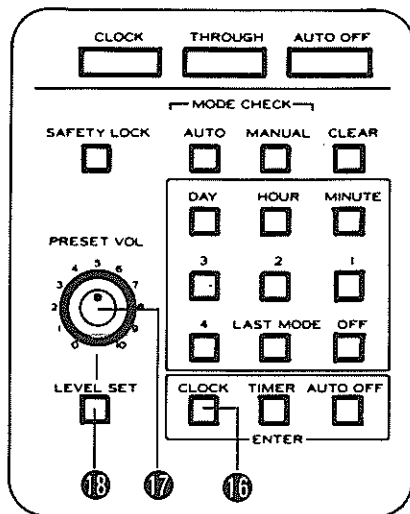

16 CLOCK (ENTER) key

Pushing this key writes the current time designated by the HOUR and MINUTE keys into the memory; the colon starts blinking to show that the clock is in operation, counting seconds from 00 (seconds not indicated on the display). To correct any seconds, from 1 to 59 seconds, ahead of the standard time, simply push when you hear the time signal. To correct any time behind the standard time, set the minutes indication one minute ahead of the standard time and push the key when the time signal is heard.

17 PRESET VOL control

Designed to preset the sound output to your preference in timer-controlled operations. With the control set, the sound level is adjusted to the preset level by a motor when the power is turned on at the designated time. The minimum setting of the PRESET VOL control (fully counterclockwise) provides you with a slight sound output when the power is turned on. For normal use, set this control to your preference and use the VOLUME keys (UP and DOWN) for further adjustment of the sound level, if necessary.

Note:

When setting the PRESET VOL control, be sure that the audio muting is not in use.

18 LEVEL SET key

Resets the sound level controlled by either the UP or DOWN key of the VOLUME to the predetermined sound level set with the PRESET VOL. control.

KEYBOARD FOR DRAWING THE SIGNAL FLOWCHART

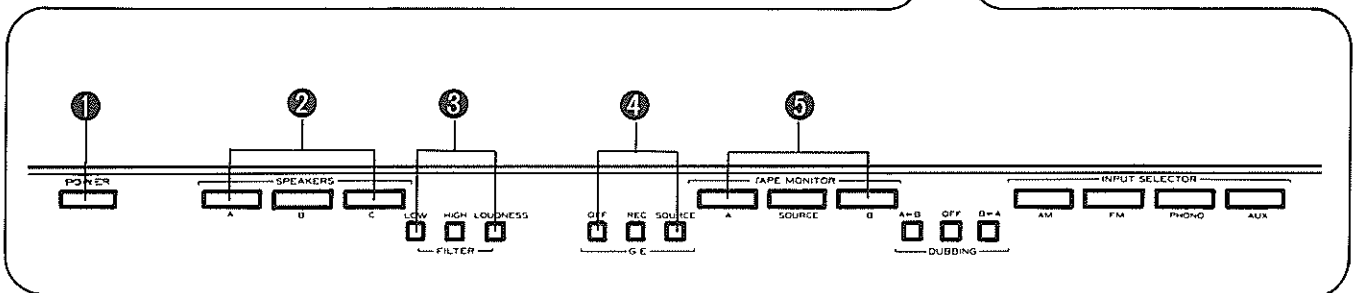
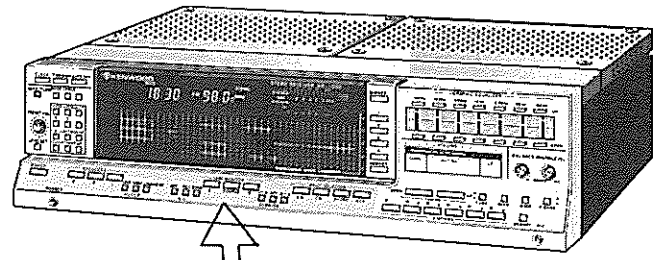

Drawing the signal flowcharts on the display with these keys is done by simply a series of keystrokes that you can press as you desire. Each keystroke switches the light of the block in the signal flowchart corresponding to the key. The signal flowchart can be drawn as you desire, watching the display as a guide. The following shows the function of each key:

① POWER key

When turning on the power manually, press this key.

② SPEAKERS keys

- A** — Activates speakers connected to the SPEAKER A terminals on the rear panel.
- B** — Activates speakers connected to the SPEAKERS B terminals on the rear panel.
- C** — Activates speakers connected to the SPEAKERS C terminals on the rear panel.

For private listening through headphones, release all the SPEAKERS keys.

③ FILTER keys

LOUDNESS — Press this key to light the LOUDNESS block on the signal flowchart. This compensates for a natural deficiency in human hearing, the human ear is less sensitive to bass notes at low volume levels. Press it again to release the loudness effect when listening at normal and loud sound level.

HIGH — Press this key to light the HIGH block on the signal flowchart. This reduces high frequency noise, such as tape hiss, record scratch, etc.

LOW — Press this key to light the LOW block on the signal flowchart. This reduces low frequency noise such as turntable rumble, etc.

④ G.E. keys (graphic equalizer)

Determine whether the source signals set by the INPUT SELECTOR key or TAPE key are to be processed by the graphic equalizer or not.

SOURCE — Inserts the graphic equalizer into the signal path to process the source signal set by the INPUT SELECTOR key or TAPE key.

REC — Inserts the graphic equalizer into the signal path for recording to process the tape source signal being recorded.

OFF — Removes the graphic equalizer from the signal path. Always set here when not using the graphic equalizer.

⑤ TAPE MONITOR keys

SOURCE — Always set here when not using a tape deck.

A — For the playback of the tape deck connected to the TAPE A jacks.

B — For the playback of the tape deck connected to the TAPE B jacks.

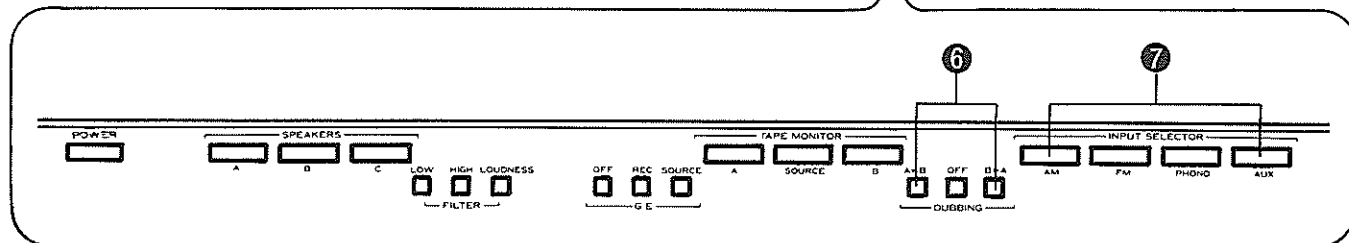
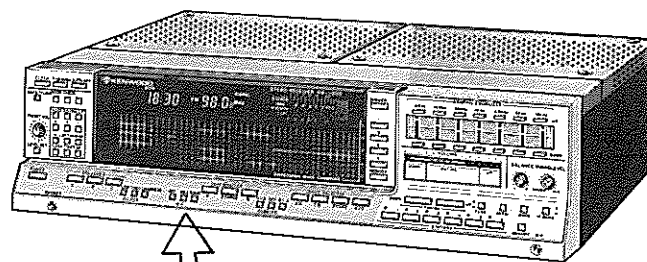

⑥ DUBBING keys

Set the type of recording.

OFF — For the recording of source signals set with one of the INPUT SELECTOR keys.

A ▶ B — For dubbing from tape A to tape B, with two tape decks connected to the TAPE A and B jacks. With this setting, the source signal set by the INPUT SELECTOR key can be heard while dubbing is in progress.

B ▶ A — For dubbing from tape B to tape A. The source signal set by the INPUT SELECTOR key can be heard while dubbing is in progress.

⑦ INPUT SELECTOR keys

Select source signals for input.

AM — For reception of AM broadcasts.

FM — For reception of FM broadcasts.

PHONE — For playback of records.

AUX — To play back the signal from the equipment connected to the AUX jacks.

PROGRAM MODE COMMANDER KEYBOARD

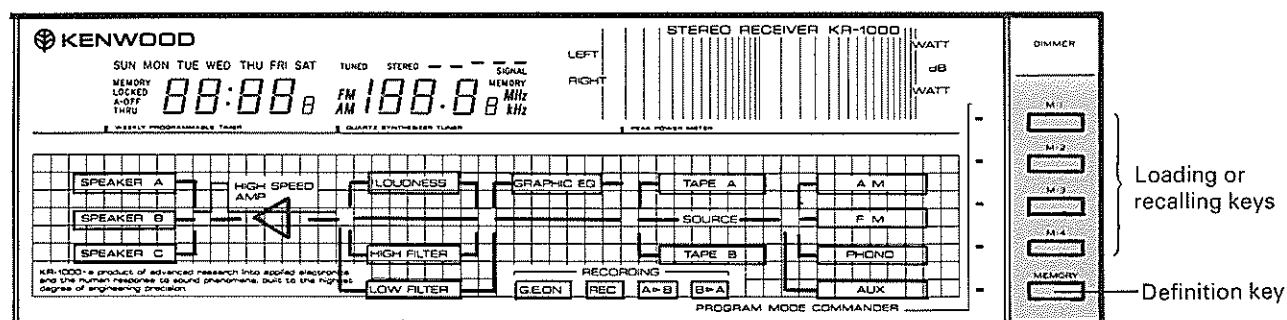

This keyboard consists of one definition key marked MEMORY and four loading and recalling keys marked M-1, M-2, M-3 and M-4. With these keys, up to four program modes, signal flowcharts combined with preset broadcasts, are stored in the memory. To store the program modes, first push the MEMORY key, then one of the keys marked M-1 through M-4. Repeat this to store other programs.

TUNER OPERATION KEYBOARD AND PUSHBUTTONS

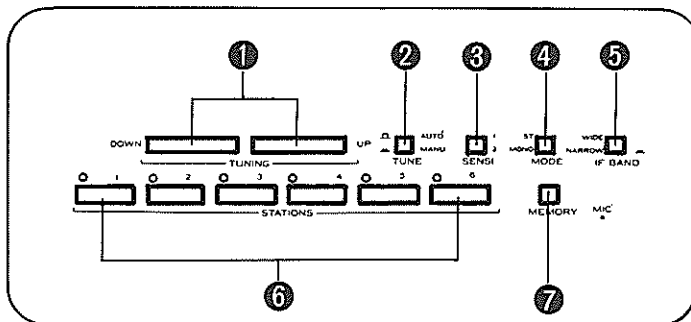
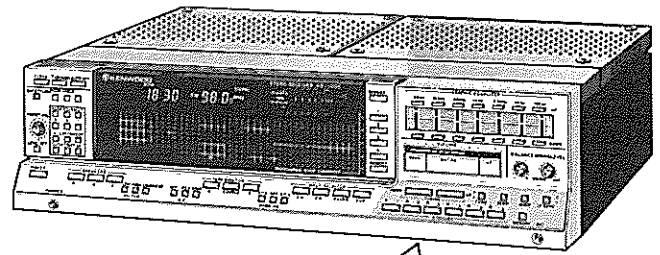

With six STATIONS keys, 6 FM and 6 AM broadcast stations can be preset to facilitate instant tuning and programmed operations.

① TUNING keys (UP and DOWN)

Auto tuning — With the TUNE pushbutton set to AUTO, when the UP key is pressed the tuning frequency indicated on the display automatically scans upward until a broadcasting station is received; pushing the DOWN key performs the opposite operation.

Manual tuning — With the TUNE pushbutton set to MANUAL, pushing the UP (DOWN) key once increases (decreases) the frequency by one step. When the key is held depressed, 2 ~ 3 seconds later the frequency is increased or decreased rapidly. When it reaches the upper (lower) limit of the frequency range, it is automatically switched to the lower (upper) limit and advances at the same speed.

② TUNE pushbutton

AUTO — This setting permits AM/FM scan tuning activated by pushing the UP or DOWN key.

MANUAL — This setting permits manual AM/FM tuning by pushing the UP or DOWN key each time or keeping it depressed.

③ SENS1 pushbutton

Setting 1 — Permits the reception of signals that are relatively weak than that of setting 2, but strong enough to produce stereo.

Setting 2 — Permits the reception of only signals that are strong enough to produce a good stereo. Switch to the setting 1 when signals do not overcome the stereo threshold level of this setting.

④ MODE pushbutton

ST — In this setting, the FM tuner section switches automatically between stereo and monaural reception in accordance with the operation of the tuned station.

MONO — The setting provides monaural operation regardless of the transmitting mode and eliminates noise in FM reception.

⑤ IF BAND pushbutton

WIDE — For normal use and minimum distortion.

NARROW — If a very strong adjacent broadcast interferes with the desired weak broadcast.

⑥ STATIONS keys

Preset AM/FM broadcasting stations and recall the preset stations for instant tuning.

⑦ MEMORY key

Press this key when storing the desired broadcasting station in the memory then the word MEMORY lights in the frequency display for about 5 seconds.

OTHER FEATURES

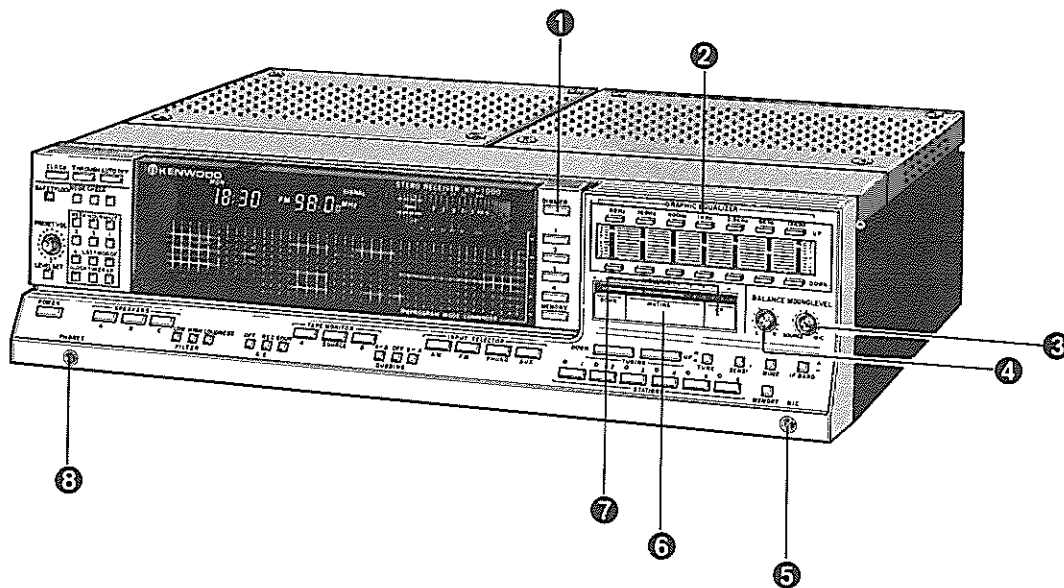

① DIMMER pushbutton

Reduces the light intensity of the whole display. Use this feature to reduce eye-strain when the receiver is operated in the dark.

② GRAPHIC EQUALIZER

Divides each channel into seven bands. Center frequencies of the seven bands are set approximately 1 octave apart at 60 Hz, 160 Hz, 400 Hz, 1 kHz, 2.5 kHz, 6 kHz and 15 kHz. The upper or lower pushbuttons permit each of these bands to be boosted or cut by up to 10 dB. With all the LEDs in the 0 dB position, the overall frequency response is flat.

③ MIXING LEVEL (MIC) control

Facilitates the mixing of your vocal accompaniment with any program sources set with the INPUT SELECTOR keys, TAPE MONITOR keys, or DUBBING keys and mixing with any sources reproduced through the graphic equalizer circuit. For further details, see page 30.

④ BALANCE control

Permits balancing of left and right channels when an imbalance exists in the source sound, or to correct acoustic imbalance due to room conditions. Move it to the left from the zero position to boost the left channel; move it to the right of the zero position to raise the level of the right channel.

⑤ MIC jack

Plug a microphone into this jack.

⑥ MUTING key

This is a convenient feature which attenuates the audio output by 20 dB without changing the VOLUME setting; use it when answering the telephone or changing a record, etc. When the key is pushed, the VOLUME setting indicator remains as it is but its light changes to red.

When the power is turned off while muting is in use, the muting is released automatically.

⑦ VOLUME keys (UP and DOWN)

This VOLUME control performs the same function of conventional ones by pushing the keys marked UP and DOWN. However, the VOLUME is interlocked with the PRESET VOL control; that is, when the PRESET VOL control is set to the desired volume level, the sound level is automatically adjusted to the preset level when power is first set on; when the PRESET VOL control is set fully counterclockwise, slight sound is output. To control the preset sound level any further, push the UP or DOWN key. When the power is turned off, the sound level is always set to zero by motor-drive. During these operations, the control setting is indicated with the blue band as a guide.

⑧ PHONES jack

Stereo headphones are plugged into this jack. When all speakers are disconnected from the signal flowchart by pressing the SPEAKERS keys, only headphones can be heard.

DISPLAY

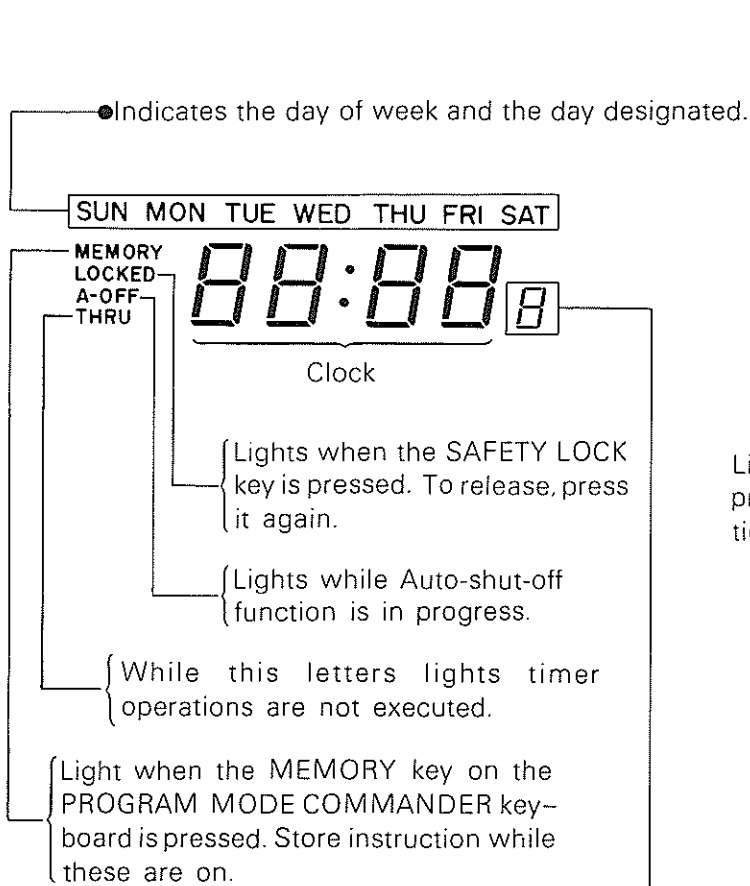

The number shown here denotes the designated program, i.e. 1 for the program stored in M-1, 4 for M-4, 5 for the program currently used, 0 for power-off instruction.

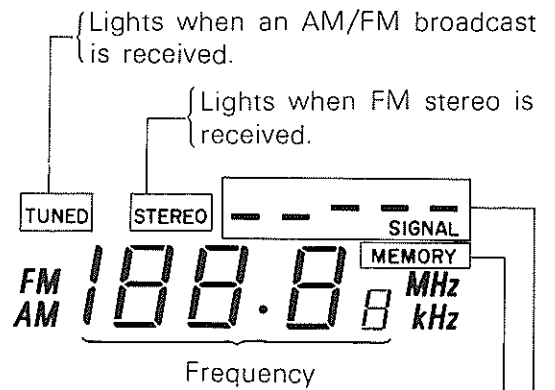

Lights when the MEMORY key is pressed. Preset broadcasting stations while it is on.

Tune to AM/FM broadcasts so that the maximum number of LEDs light.

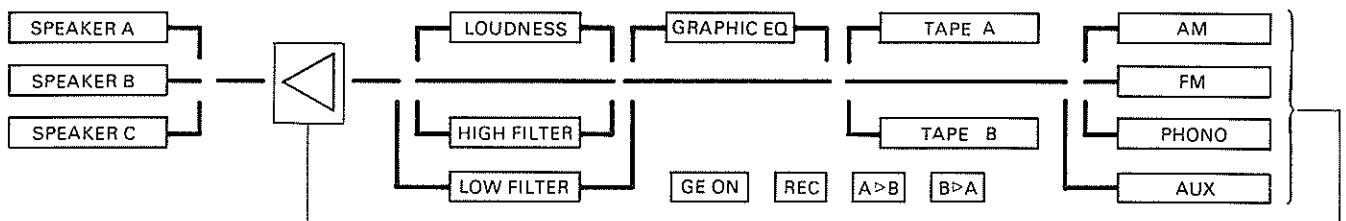

Flashes for 2 ~ 3 seconds until the power supply stage is stabilized. This will also flash if any abnormality occurs in the power output stage.

Current signal path from input to output.

PRESETTING OPERATIONS

When the power plug is connected to the AC line outlets!

The indication shown below is displayed on the timer display.

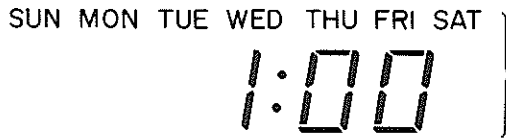

The whole indication flashes.
This is not the sign of a fault, but denotes that the clock has not yet been set.

HOW TO SET THE CLOCK

Two examples are given below to show you how to set the clock. Referring to these procedures set the clock to your local time in accordance with the standard time signal.

Example 1: 9:30 PM on Wednesday

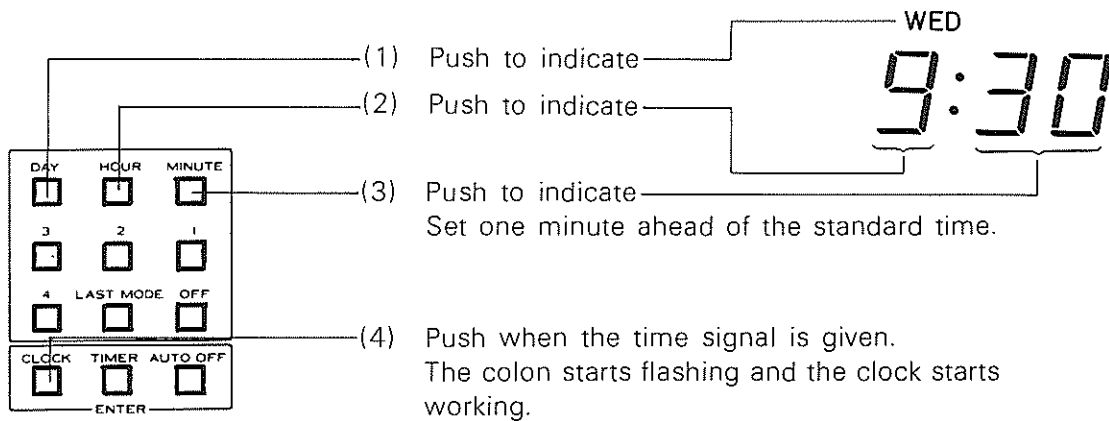

Example 2: 4:45 PM on Saturday

- (1) Push the DAY key to indicate the letters "SAT".
- (2) Push the HOUR key to set hours to "16".
- (3) Push the MINUTE key to set minutes to "45".
- (4) Wait until you hear the standard time signal at 4:45, then push the CLOCK (ENTER) key.

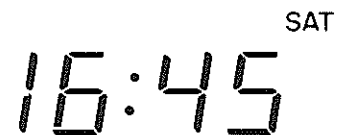

HOW TO PRESET BROADCASTING STATIONS

Before turning on the power switch, be sure that the PRESET VOL control is fully turned counterclockwise. When you first turn on the power switch after the power plug has been plugged into an AC line outlet, the factory defined signal flowchart (original contents) shown below is displayed automatically.

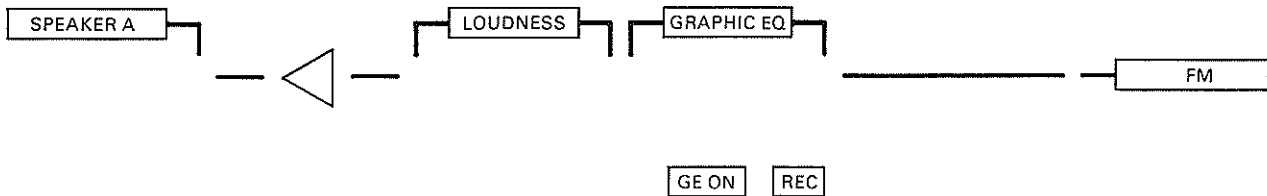

Use this signal flowchart for presetting which is described as follows:

FM PRESETTING

1. Set the TUNE pushbutton to AUTO.
2. Push the UP or DOWN key to tune to the desired broadcast.
3. Adjust the volume with the UP or DOWN VOLUME key to adjust to the desired sound level.
4. Push the MEMORY key; the word MEMORY will light up in the frequency display.
5. Push the STATIONS key marked 1 to store the received station while the MEMORY indicator is still lit.
6. Repeat steps 2 through 5 to store the rest of the desired broadcasting stations with the STATIONS keys marked 2 through 6.

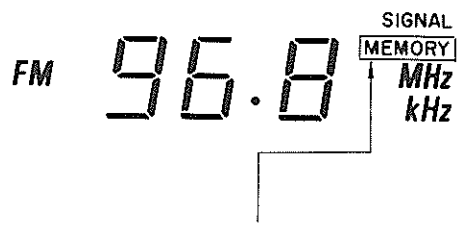
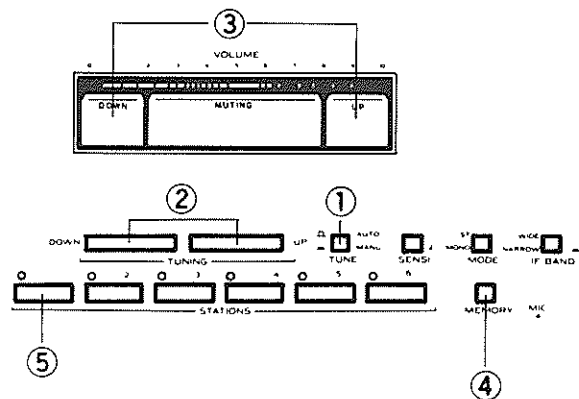

Be sure to preset a broadcast by pressing one of the STATIONS keys while the word MEMORY is on.

AM PRESETTING

1. Push the AM key of INPUT SELECTOR to modify the signal flowchart used for FM presetting for the reception of AM broadcasts.
2. Repeat steps 2 through 6 described in the preceding "FM PRESETTING" to store the desired six AM broadcasting stations.

HOW TO DRAW SIGNAL FLOWCHARTS

With this keyboard, drawing any desired signal flowcharts is easily done by a series of keystrokes. To load the whole signal flowchart drawn on the display into the memory, press the MEMORY key of PROGRAM MODE COMMANDER then one of the keys marked M-1 through M-4. Four signal flowcharts can be stored with this keyboard by repeating the procedure.

Before drawing the signal flowchart, summon the original contents (factory defined signal flowchart), shown below by pressing the M-1 key.

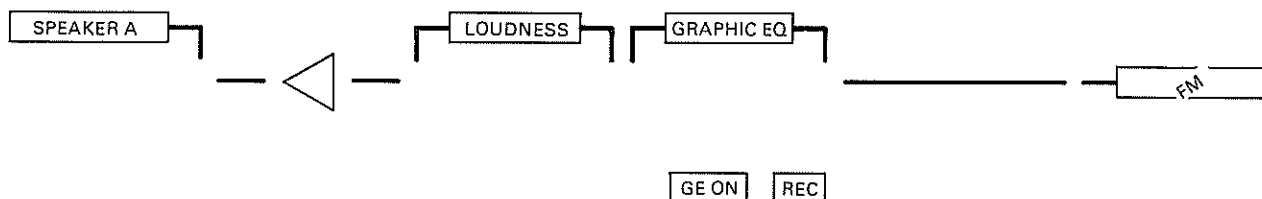

If the above signal flowchart is what you want, press the MEMORY key then the key marked M-1 to store it.

To modify the above signal flowchart to the one shown below, press the LOUDNESS key and the OFF G. E. key in any order.

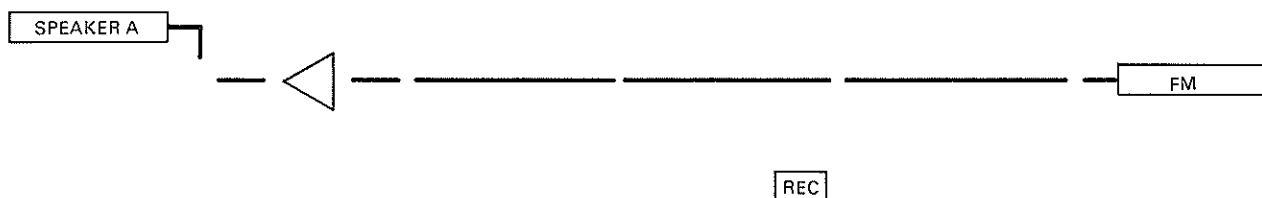

To store the above signal flowchart, press the MEMORY key then the key marked M-2.

To add speaker B to the above signal flowchart, simply press the SPEAKERS key marked B. Then you obtain the signal flowchart shown below.

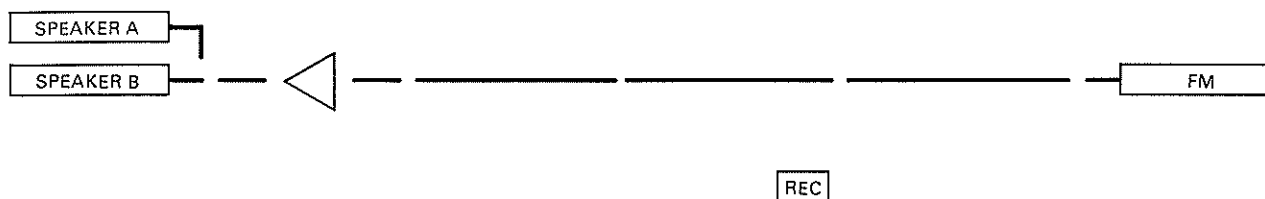

Press the MEMORY key and the key marked M-3 to store the above signal flowchart into the memory.

To insert the graphic equalizer into the above signal path, press the SOURCE G. E. key to obtain the signal flowchart shown on the following page.

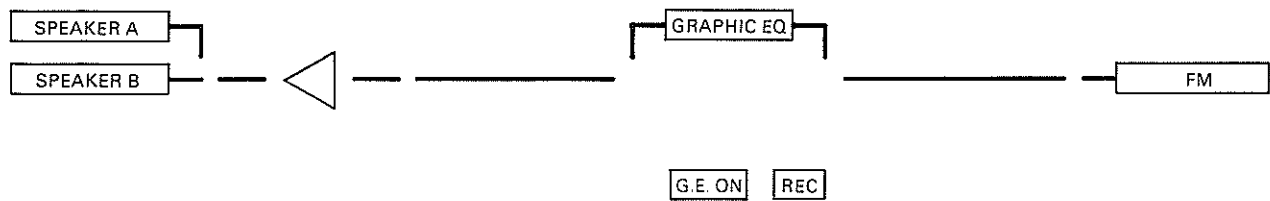

Press the MEMORY key and the key marked M-4 to store it.

These four signal flowcharts stored in the memory remain intact unless other new signal flowcharts are loaded by similar procedures as seen in the above examples. In other words, no matter how you modify the signal flowchart stored in M-4, for example, by pushing the keys, the stored signal flowchart will be displayed any time when the M-4 key is pressed.

HOW TO COMBINE SIGNAL FLOWCHART AND PRESET STATION

To combine FM (AM) stations, proceed as follows:

1. Press one of the PROGRAM MODE COMMANDER keys marked M-1 through M-4 to summon the signal flowchart set to FM (AM) input.
2. Press one of the STATIONS keys marked 1 through 6 to receive the desired broadcast.
3. Press the MEMORY key of the PROGRAM MODE COMMANDER then the key used in the step 1 to store the combination of the signal flowchart and FM (AM) station indicated on the display.
4. Repeat steps 1 through 3 to store other combinations.

TIMER PROGRAMMING

Example 1-a: A daily routine program setting

Listening to FM (A) broadcast from 6:00 to 7:00 AM daily.

Before starting programming, the program mode to be used will be referred to the one shown below:

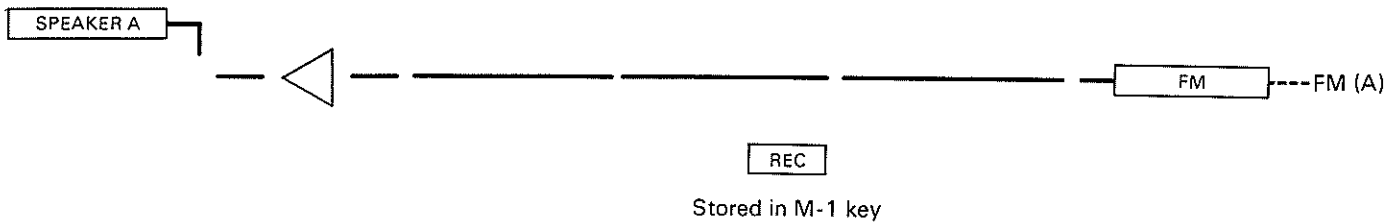

Timer programming keyboard

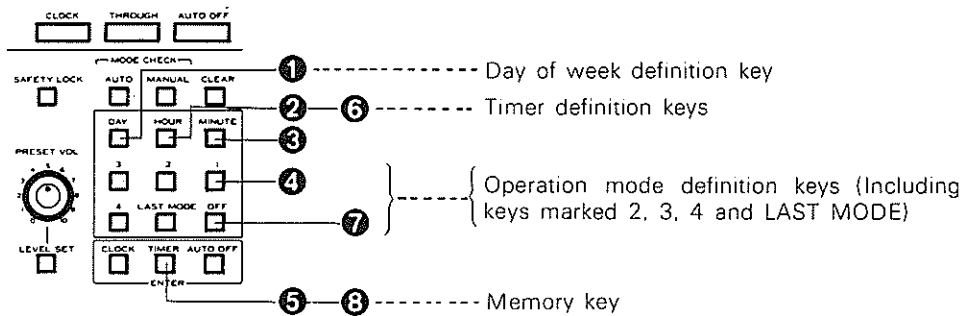

Press

Timer display

- | | | |
|---|------------------------------|---|
| <p>1 DAY to indicate</p> <p>2 HOUR to set</p> <p>3 MINUTE to set</p> <p>4 Key marked 1</p> <p>5 TIMER (ENTER) to store</p> <p>6 HOUR to set</p> <p>7 OFF</p> <p>8 TIMER (ENTER)</p> |

 | <p>—:—</p> <p>6:—</p> <p>6:00</p> <p>6:00 □ — { Lights to show that the program mode stored in the M-1 is defined.</p> <p>6:00 □ — { Blinks to show that the above definition is stored.</p> <p>7:00</p> <p>7:00 □ — { Lights to show that the turn-off instruction is defined.</p> <p>7:00 □ — { Blinks to show that the above definition is stored.</p> |
|---|------------------------------|---|

Now, the programming is completed. The program is executed daily at the designated time unless the THROUGH key is pressed or the program is cleared with the CLEAR key.

Extended programming example is shown on the following page.

Example 1-b: Extended programming using the Example 1-a

Turning on speaker B at 6:30 to wake up a person in a different room.

Before starting programming, press the M-1 key so the program mode is displayed and modify by adding speaker B by pressing the SPEAKERS key marked B. The following is the modified signal flowchart.

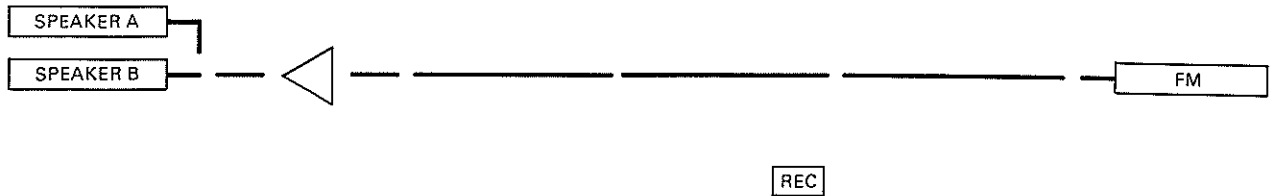

Press the MEMORY key and the M-2 to store the above modified signal flowchart.

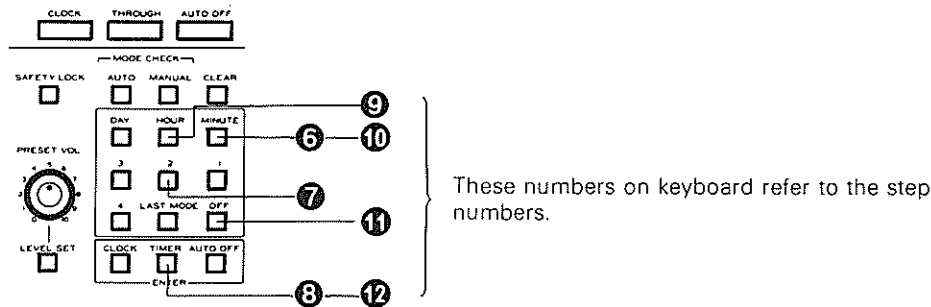

First carry out steps 1 through 5 shown in the preceding Example 1-a and then the following procedure.

Press	Timer display
6 MINUTE to set	6:00 1 05 1 20 1 29 1 30 1
7 Key marked 2	6:30 2 — Lights to show that the program mode stored in M-2 is defined.
8 TIMER (ENTER) to store	6:30 2 — Blinks to show that the above instruction is stored.
9 HOUR to set	7:30 2
10 MINUTE to set	7:30 2 50 2 59 2 00 2
11 OFF	7:00 0 — Lights show that the turn-off instruction is defined.
12 TIMER (ENTER) to store	7:00 0 — Blinks to show that the above definition is stored.

Example 2-a: Executing various programs on same day

Listening to FM (A) broadcast stored in M-1 from 9:00 to 10:30 and to FM (B) broadcast stored in M-2 from 10:30 to 11:00 on Sunday morning.

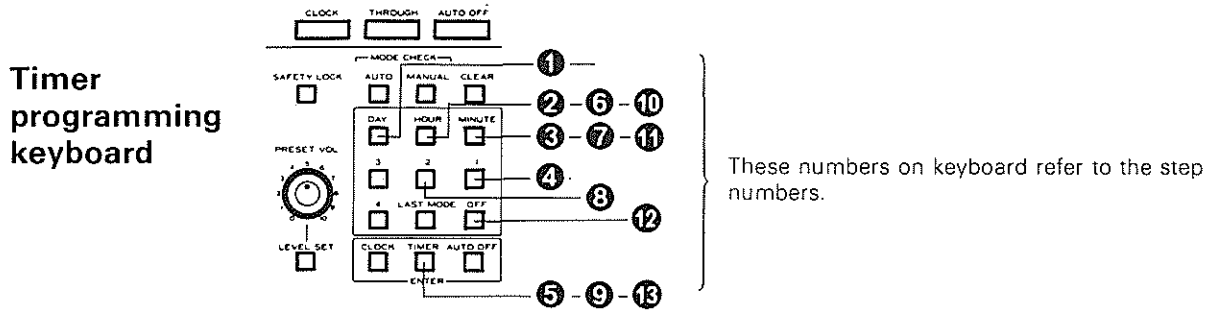

Press		Timer display
		SUN
① DAY	to indicate	-- : --
② HOUR	to set	9 : --
③ MINUTE	to set	9 : 00
④ Key marked 1		9 : 00 1 — { Lights to show that the program mode stored in M-1 is defined.
⑤ TIMER (ENTER)	to store	9 : 00 1 — { Blinks to show that the above definition is stored.
⑥ HOUR	to set	10 : 00 1
⑦ MINUTE	to set	10 : 00 1 05 1 20 1 29 1 30 1
⑧ Key marked 2		10 : 30 2 — { Lights to show that the program mode stored in M-2 is defined.
⑨ TIMER (ENTER)	to store	10 : 30 2 — { Blinks to show that the above definition is stored.
⑩ HOUR	to set	11 : 30 2
⑪ MINUTE	to set	11 : 30 2 50 2 59 2 00 2
⑫ OFF		11 : 00 0 — { Lights to show that the turn-off instruction is defined.
⑬ TIMER (ENTER)	to store	11 : 00 0 — { Blinks to show that the above definition is stored.

Example 2-b: The following programming is continued from Example 2-a

Listening to the same program FM (B), operated last in the morning, from 3:00 to 4:15 and to FM (C) broadcast stored in M-3 from 4:15 to 6:00 on Sunday afternoon.

Timer programming keyboard

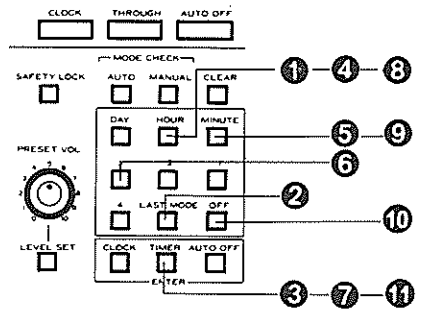

These numbers on keyboard refer to the step numbers.

<u>Press</u>	<u>Timer display</u>	
	11:00 _B	Last instruction stored in Example 2-a.
① HOUR to set	15:00 _B	
② LAST MODE	15:00 _B	{ Lights to show that the program mode used in the preceding instruction is defined again.
③ TIMER (ENTER) to store	15:00 _B	{ Blinks to show that the above definition is stored.
④ HOUR to set	16:00 _B	
⑤ MINUTE to set	16:00 _B 05 _B 10 _B 15 _B	
⑥ Key marked 3	16:15 _B	{ Lights to show that the program mode stored in M-3 is defined.
⑦ TIMER (ENTER) to store	16:15 _B	{ Blinks to show that the above definition is stored.
⑧ HOUR to set	18:15 _B	
⑨ MINUTE to set	18:15 _B 30 _B 40 _B 50 _B 00 _B	
⑩ OFF	18:00 _B	{ Lights to show that the turn-off instruction is defined.
⑪ TIMER (ENTER) to store	18:00 _B	{ Blinks to show that the above definition is stored.

Example 3: Eight programs in the memory and their executions

Before starting the explanation of the timer programmed operations as shown in the figure below, the program modes stored in the PROGRAM MODE COMMANDER keys marked M-1 through M-4 will be referred by the letters (A), (B), (C) and (D).

Contents of the letters are:

- (A) Signal flowchart combined with FM 1 stored in the STATIONS key marked 1 stored in M-1
- (B) Signal flowchart combined with FM 2 stored in the STATIONS key marked 2 stored in M-2
- (C) Signal flowchart combined with FM 3 stored in the STATIONS key marked 3 stored in M-3
- (D) Signal flowchart combined with AM 1 stored in the STATIONS key marked 1 stored in M-4

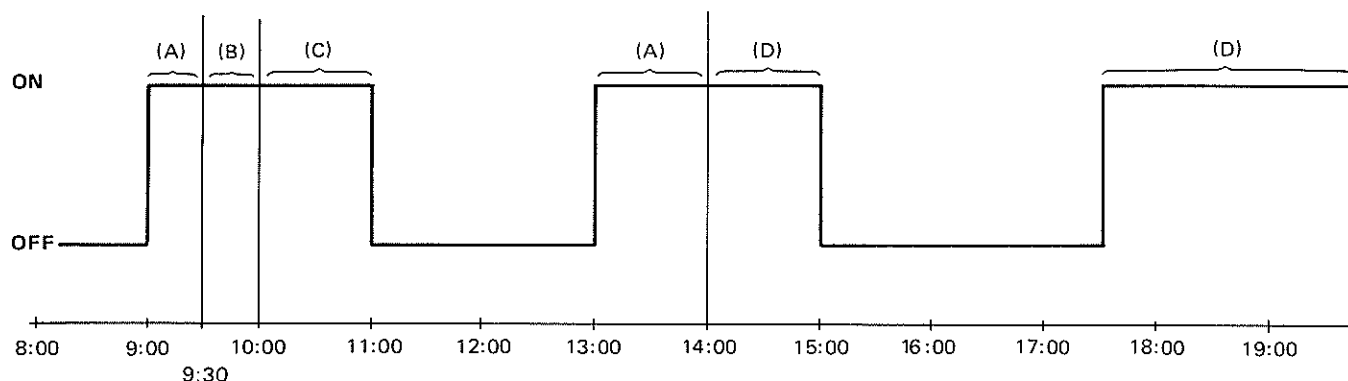
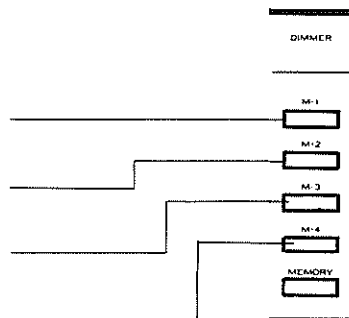

Example of the timer programs

How to write the above programs into the memory

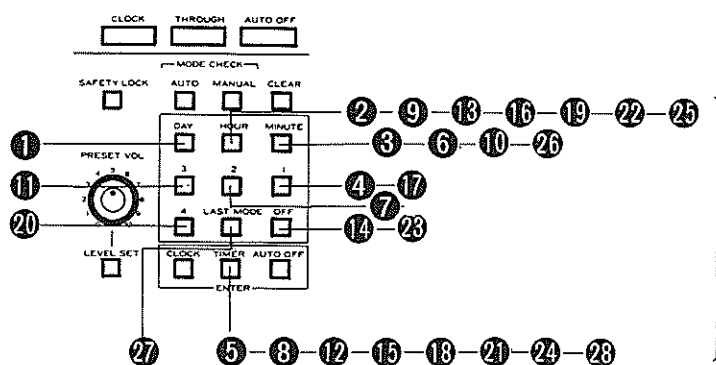

These numbers refer to the step numbers on the following page.

Proceed as follows:

- ① Press the DAY key to define the day when the programs are to be executed.
- ② Press the HOUR key to set the hour indication to "9".
- ③ Press the MINUTE key to set the minute indication to "00".
- ④ Press the program mode definition key marked 1 to define the program mode (A) stored in M-1.
- ⑤ Press the TIMER (ENTER) key to store the above definition into the memory **(first program)**
- ⑥ Press the MINUTE key to set the minute indication to "30".
- ⑦ Press the program mode definition key marked 2 to define the program mode (B) stored in M-2.
- ⑧ Press the TIMER (ENTER) key to store the above definition into the memory **(second program)**
- ⑨ Press the HOUR key to set the hour indication to "10".
- ⑩ Press the MINUTE key to set the minute indication to "00".
- ⑪ Press the program mode definition key marked 3 to define the program mode (C) stored in M-3.
- ⑫ Press the TIMER (ENTER) key to store the above definition into the memory **(third program)**
- ⑬ Press the HOUR key to set the hour indication to "11".
- ⑭ Press the turn-off definition key marked OFF to define the turn-off instruction.
- ⑮ Press the TIMER (ENTER) key to store the above definition into the memory **(fourth program)**
- ⑯ Press the HOUR key to set the hour indication to "13".
- ⑰ Press the program mode definition key marked 1 to define the program mode (A) stored in M-1.
- ⑱ Press the TIMER (ENTER) key to store the above definition into the memory **(fifth program)**
- ⑲ Press the HOUR key to set the hour indication to "14".
- ⑳ Press the program mode definition key marked 4 to define the program mode (D) stored in M-4.
- ㉑ Press the TIMER (ENTER) key to store the above definition into the memory **(sixth program)**
- ㉒ Press the HOUR key to set the hour indication to "15".
- ㉓ Press the turn-off instruction key marked OFF to define the turn-off instruction.
- ㉔ Press the TIMER (ENTER) key to store the above definition into the memory **(seventh program)**
- ㉕ Press the HOUR key to set the hour indication to "17".
- ㉖ Press the MINUTE key to set the minute indication to "30".
- ㉗ Press the program mode definition key marked LAST MODE to define the program mode used before the power was last turned off.
- ㉘ Press the TIMER (ENTER) key to store the above definition into the memory **(eighth program)**

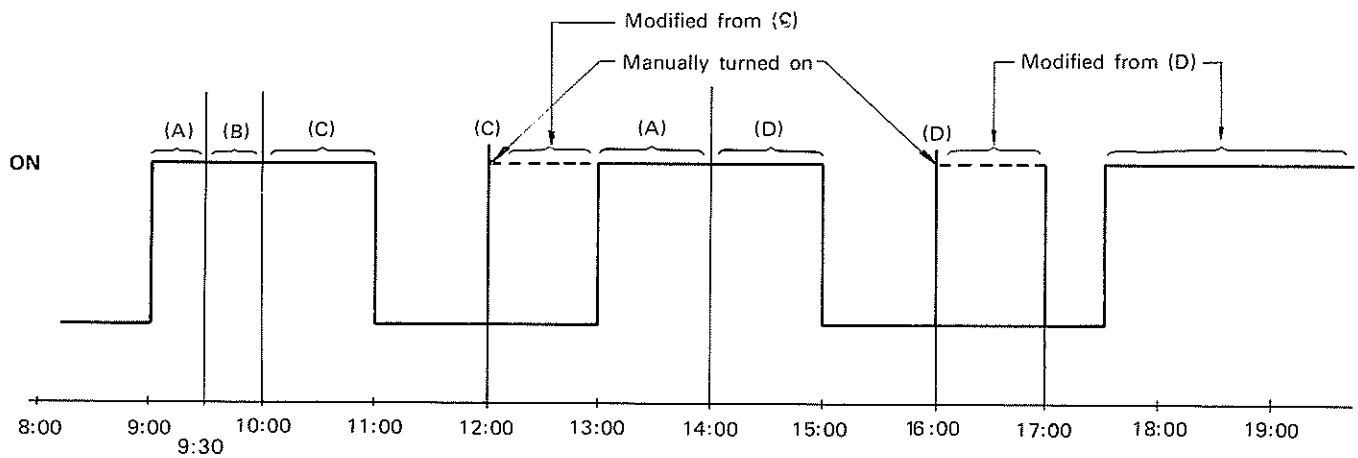

Execution of the timer programs

When the above timer programmed operations are executed:

1. The unit is automatically turned on at 9:00 with the operation mode (A) stored in M-1.
2. At 9:30, the above operation mode (A) is automatically switched to the one (B) stored in M-2.
3. At 10:00 the above operation mode (B) is switched to the one (C) stored in M-3 and the unit is turned off at 11:00.
4. At 12:00 when you turn the unit on manually in an attempt to play the tape deck, the same operation mode (C) appears on the display again. Modify this operation mode by pressing the TAPE MONITOR key marked A or B in order to play back the tape deck connected to the TAPE A or B jacks.
5. At 13:00 the above modified operating mode is automatically switched to the one (A) stored in M-1.
6. At 14:00 the operating mode (A) is switched to the one (D) stored in M-4 and the unit is turned off at 15:00 automatically.
7. At 16:00 when you turn the unit on manually in an attempt to play a record, the same operation mode (D) appears again on the display. Modify this operation mode by pressing the INPUT SELECTOR key marked PHONO in order to modify the signal flowchart. At 17:00 the unit is turned off manually.
8. At 17:30 the unit is turned on with the same operation mode use previously. This is because the timer program is designated by the LAST MODE instruction. So, if the manual operation stated in item 7 is not carried out, the program mode (D) terminated at 15:00 will appear again when the unit is automatically turned on at 18:00.

AUTOMATIC SHUT-OFF SETTING

This feature can be used when making an unattended recording or before going to sleep.

Example: 30 minutes later shut-off setting

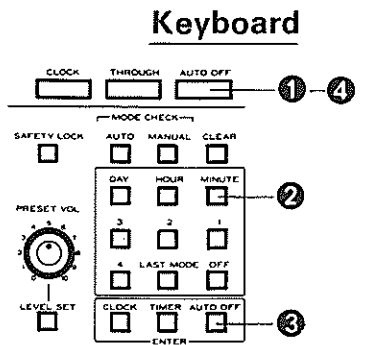

These numbers refer to the step numbers.

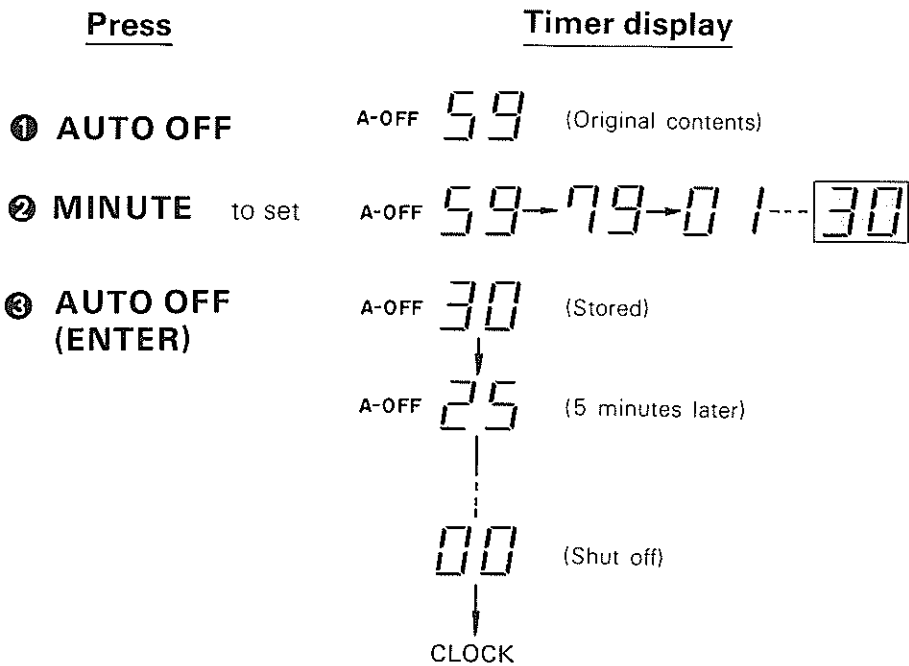

When executing the shut-off instruction

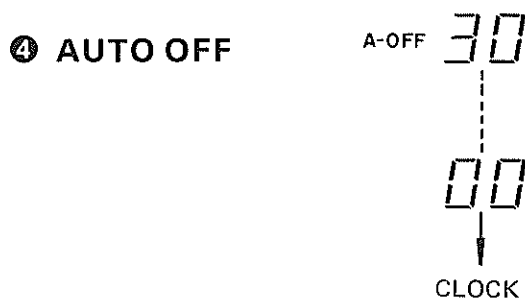

By this procedure you can set the shut-off setting to any value from 1 through 79 minutes.

Continued from the preceeding page:

If you want to change the shut-off time from 30 to 20 minutes, for example, press the MINUTE key to indicate 20 on the timer display and repeat steps 3 and 4 described in above example. Proceed as follows:

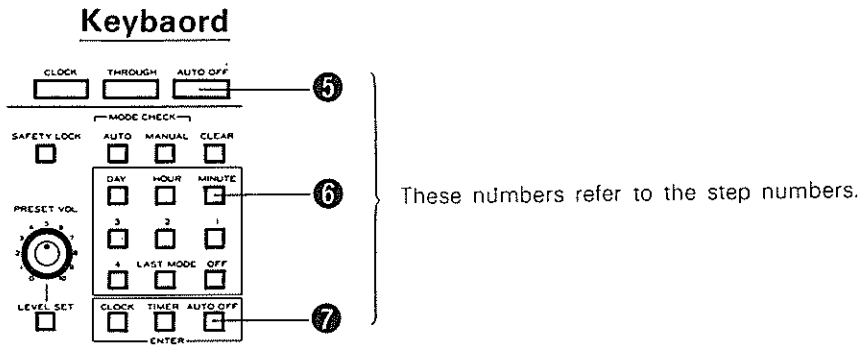

When changing the shut-off time from 30 to 20 minutes

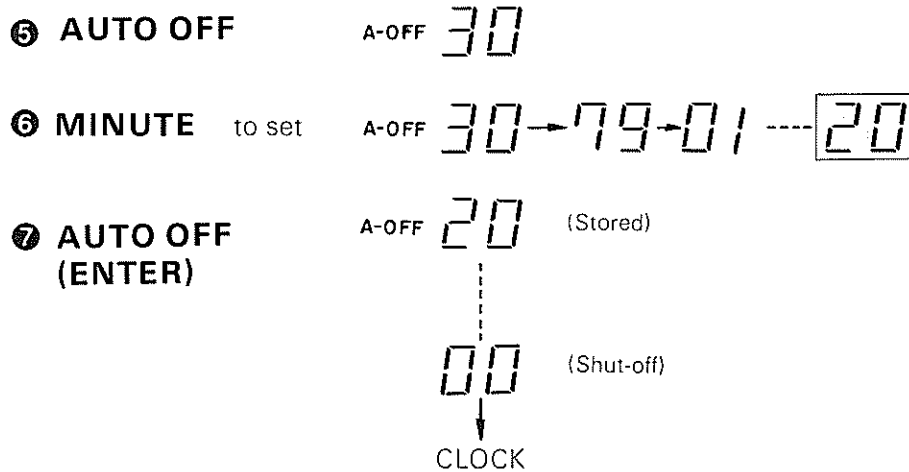

Once the desired shut-off time is stored in the memory the instruction remains intact unless a new instruction is stored in the memory by pushing the AUTO OFF (ENTER) key. So, when executing the instruction by pushing the AUTO OFF key, the display shows the set minutes. However, disconnecting the power plug or power failuer clears the instructions stored in the memory except for original contents. The first time AUTO OFF key is set after connecting the power, the display shows 59 minutes and this factory defined instruction is executed each time until a new instruction is given.

OPERATING INSTRUCTIONS

AM/FM RECEPTION

With this receiver, three different ways of tuning are possible; automatic tuning; manual tuning and tuning with preset keys.

For initial setup, press the POWER key to turn the unit on and arrange the signal flowchart on the display, if needed, in order to connect the tuner section by pressing the INPUT SELECTOR key marked FM or AM then proceed as follows:

Preset tuning

1. Press one of the STATIONS keys corresponding to the required broadcast station.
Six broadcast stations have been preset by the procedures described in FM/AM PRESETTING on page 17.
2. Adjust to the required volume with the VOLUME keys.
3. When adjusting the tone, press the G.E. key marked SOURCE and depress the upper or lower pushbuttons of the GRAPHIC EQUALIZER according to your requirements.

Auto tuning

1. Set the TUNE pushbutton to AUTO (out).
2. Press the TUNING key marked UP or DOWN.
The frequency in the display increases or decreases until the next station is received.
3. Adjust to the required volume with the VOLUME keys.
4. When adjusting the tone, press the G.E. key marked SOURCE and depress the upper or lower pushbuttons of the GRAPHIC EQUALIZER according to your requirements.

Extended use of auto tuning

Six broadcast stations are preset in the STATIONS keys marked 1 through 6, which are referred to by the letters A through F shown in the figure below.

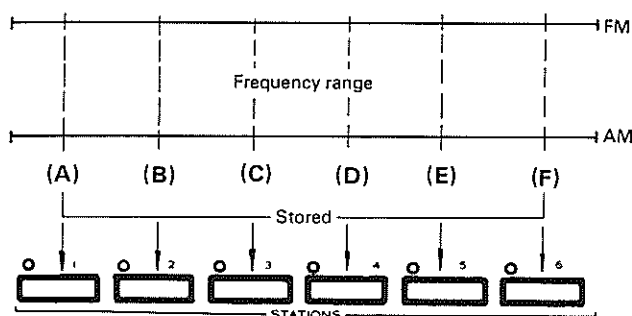

Stations A through F are located over the whole range, at approximately the same interval.

Proceed as follows:

1. Set the TUNE pushbutton to AUTO (out).
2. Press the STATIONS key marked 4 or 5 to receive the preset station D or E.
3. Press the TUNING key marked UP or DOWN to search for broadcasts between the two preset stations.
4. To search for broadcasts between the preset stations A and B, press the STATIONS key marked 1 or 2 and proceed from step 3.
This procedure gives a quick access to broadcasts.

Manual tuning

To receive the desired frequency directly or to receive stations whose signal strength is too weak for automatic tuning, use manual tuning.

Proceed as follows:

1. Set the TUNE pushbutton to MANUAL (in).
2. Press one of the STATIONS keys marked 1 through 6 according to the station to be received.
3. Press the TUNING key marked UP or DOWN momentarily or keep it pressed until the desired frequency is indicated on the display.
The TUNED indicator lights when correct tuning is attained.
4. Adjust to the required volume with the VOLUME keys.
5. When adjusting the tone, press the G.E. key marked SOURCE and depress the upper or lower pushbuttons of GRAPHIC EQUALIZER according to your desire.

TURNTABLE

Press the POWER key to turn on the unit and modify the signal flowchart set to PHONO, if necessary.

Proceed as follows:

1. Operate the turntable to play the record.
2. Adjust to the required volume with the VOLUME keys.
3. When adjusting the tone, press the G.E. key marked SOURCE and depress the upper or lower pushbuttons of the GRAPHIC EQUALIZER according to your requirements.

AUX

Press the POWER key to turn on the unit and modify the signal flowchart set to AUX, if necessary.

Proceed as follows:

1. Operate the equipment connected to the AUX jacks.
2. Adjust to the required volume with the VOLUME keys.
3. When adjusting the tone, press the G.E. key marked SOURCE and depress the upper or lower pushbuttons of the GRAPHIC EQUALIZER according to your requirements.

TAPE DECKS

Turn on the power then proceed as follows:

Tape playback

1. Press the TAPE MONITOR key A or B corresponding to the tape deck connected to the TAPE A or TAPE B jacks.
2. Operate the tape deck connected to the TAPE jacks and playback the tape.
3. Adjust the volume by pressing the UP or DOWN key.

Recording (with one tape deck)

1. Connect the tape deck to the TAPE A or TAPE B jacks.
2. Press one of the INPUT SELECTOR keys to set to the desired program source.
3. Set up your tape deck for recording.
4. Set the recording level with the controls of your tape deck.
5. Adjust listening level and tone to your preference while monitoring the signal being recorded.

Recording (with two tape decks)

1. Connect two tape decks to the TAPE A and TAPE B jacks.
2. Press one of the INPUT SELECTOR keys to set to the desired program source.
3. Set up your tape decks for recording.
4. Set recording levels with the controls of your tape decks.
5. Adjust listening level and tone to your preference while monitoring the signal being recorded.

Monitoring

If your tape deck has three heads, you can compare the sound quality of the recording in progress with that of the source material by pressing the appropriate TAPE MONITOR keys to set to SOURCE and A (or B) while the recording is being made.

WHEN USING A MICROPHONE

Basic operation of the mic mixing:

For initial setup, turn the power on and set the source signal to be mixed, press the VOLUME key marked UP to set the sound level to your preference then proceed as follows:

1. Plug a microphone into the MIC jack.
2. Push the G.E. key marked REC or SOURCE to insert the MIC MIXING circuit into the signal path in accordance with the mixing required.
3. Adjust the MIXING LEVEL control to obtain the desired mixing ratio of source and mic input.
4. For further adjustments of sound level, use the VOLUME keys to adjust the overall sound level so that the mixing ratio of microphone input and source will not change.

Note:

The MIC MIXING circuit is not activated unless the VOLUME key marked UP or DOWN is once pressed. Therefore, when the sound level is controlled only with the PRESET VOL control, mic mixing is not possible.

To mix with source:

1. Press the G.E. key marked SOURCE to insert the mic mixing circuit into the signal path.
2. Set the source input with one of the INPUT SELECTOR keys.
3. Use the microphone and adjust the MIXING LEVEL control to the desired mixing ratio.
4. Adjust the VOLUME (UP or DOWN key) to your preference.

If a tape deck is connected to the TAPE A or B jacks, this mixed operation can be recorded. At this time, ensure that the indicator behind the letters REC or the signal flowchart lights; if not, press the DUBBING key marked OFF.

To mix with a tape source to be dubbed:

1. Press the G.E. key marked REC to insert the mic mixing circuit into the dubbing signal path.
2. Press the DUBBING key marked A ▷ B or B ▷ A according to your requirements.
3. Set the tape deck to be played back in operation.
4. Adjust the mixing ratio in the same way described in the above basic operation of mic mixing.
5. Set the other tape deck in recording mode to dub the mixed operation.

Note:

When the microphone is not in use, make it a rule to set the MIXING LEVEL control to SOURCE, fully counterclockwise. This prevents the source signal level from being attenuated.

TIMER PROGRAMMED TAPE PLAYBACK

Timer programmed tape playback

If your tape deck has a timer stand-by feature, the following operation is available:

1. Connect the tape deck's AC power plug to one of the SWITCHED outlets on the rear panel of this receiver.
2. Modify the signal flowchart for the playback of the tape deck by pressing the TAPE MONITOR key marked A or B corresponding to the deck connected.
3. Turn on the power switch of the tape deck to be used for playback.
4. Set the tape deck to stand-by with the playback mode (follow the instructions of the deck's manual).
5. Make up the timer program with the timer keyboard of this receiver so that the program is executed at the designated time.
6. Be sure that the PRESET VOL control is adjusted to the appropriate listening level.

Use this feature for wake up operation at any designated time.

Unattended recording

If your tape deck has a timer stand-by feature, the following operation is possible:

1. Connect the tape deck's AC power plug to one of the SWITCHED outlets on the rear panel of this receiver.
2. Turn on the power switch of the tape deck to be used for recording.
3. Set the tape deck to the stand-by recording mode (follow the instructions in the deck's manual).
4. Set up the timer program with the timer keyboard of this receiver according to the length of tape used so that the program is executed at the designated time and terminated when the recording is complete.
5. Be sure that the PRESET VOL control is turned fully counterclockwise to minimize the volume.

Unattended recording with the automatic shut-off (AUTO-OFF) feature

The tape deck connection remains set as above, proceed as follows:

1. Set the source to be recorded.
2. Set the tape deck in recording mode.
3. Press the AUTO-OFF key and set the shut-off time according to the length of tape (C-60, C-90, etc.) used. For setting the time. See pages 27 and 28.

Now, you can go out while the recording is in progress and, at the designated time, the power is shut off.

HOW TO CLEAR THE TIMER PROGRAMS AND STORE NEW ONES

When clearing all timer programs from the memory

1. Press the MANUAL (MODE CHECK) key once to summon the programs to the top of the memory.
2. Keep pressing the CLEAR key momentarily until the current time is still displayed.
3. Load new programs in the same procedure described in the example 1 on pages 20 and 21.

When clearing some of the programs in the memory

1. Press the MANUAL (MODE CHECK) key each time until the program to be cleared is shown in the timer display.
2. Press the CLEAR key once to clear the program indicated in the timer display.
3. Repeat the steps 1 and 2 to clear any required programs.
4. Load new programs by the same procedure described in the example 1 on pages 20 and 21.

Note:

You can load programs into the memory in any order you desire so that the microcomputer arranges the programs in the sequence in which they are to be executed.

EFFECTIVE USE OF THE GRAPHIC EQUALIZER

1. The graphic equalizer may be used as a simple noise reduction system. In the taping process, for instance, press the upper pushbuttons of 6 and 15 kHz to give preemphasis in the high frequency range where most conspicuous noise and hiss components are present. During playback, provide a tape a deemphasis by completely reversing the preemphasis response. This process will considerably reduce the annoying background hiss from the tape while maintaining the frequency response of the original signal so that it is nearly flat.

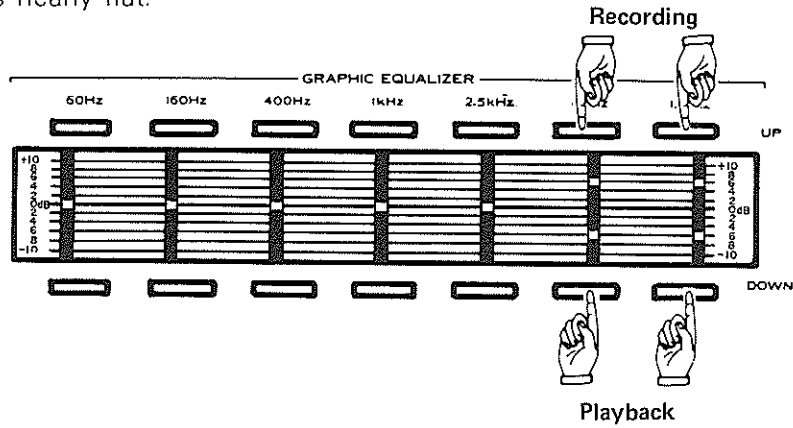

2. Unlike floor-standing or large book-shelf speaker systems, compact one or two way loudspeaker systems usually have limited low and high-end response. To compensate for this tendency, adjust the 60 Hz by pressing the upper pushbutton for the low-end response, and 6 and 15 kHz for the high-end response on a trial-and-error basis.

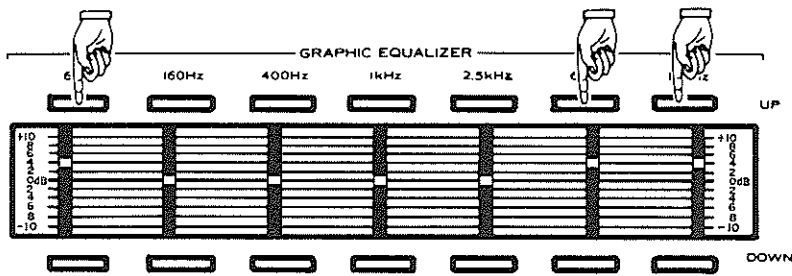

3. The graphic equalizer may also be used to eliminate annoying tape hiss or record scratch noise generated during playback. For this use the 6 and 15 kHz lower pushbuttons.

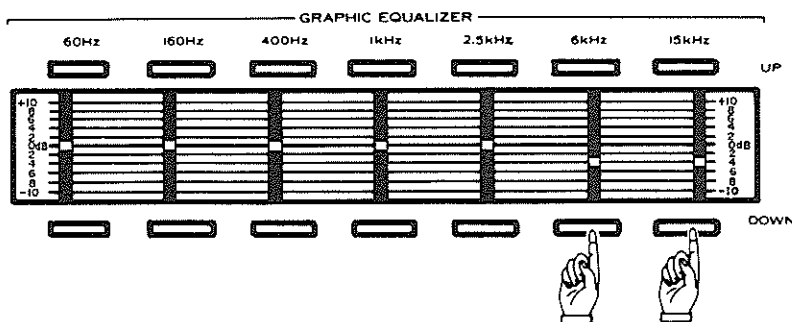

- Low frequency and subsonic noise, such as hum, rumble, and low frequency vibrations, can be effectively suppressed by adjusting the 60 Hz lower pushbutton.

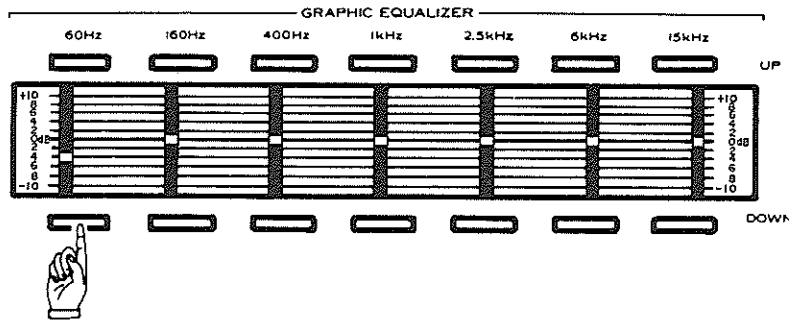

- When you wish to add "punch" to your music, emphasize low and mid frequency bands of 160, and 400 Hz and 1 kHz.

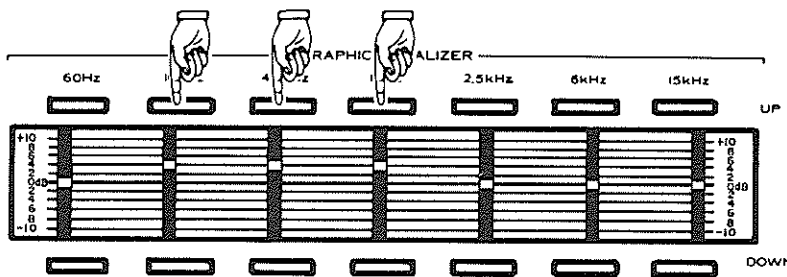

- To spotlight the vocal out of its orchestral background, increase the 400 Hz, 1 kHz or 2.5 kHz by pressing the upper pushbuttons, where most of the vocal energy is concentrated.

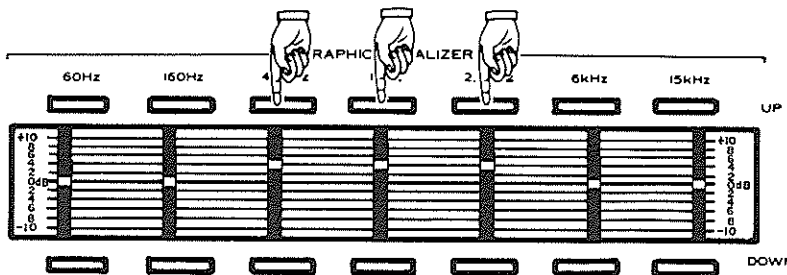

IN CASE OF DIFFICULTY

If your receiver should not perform as expected, consult the table below to see if the problem can be corrected before seeking help from your Kenwood dealer or service representative.

AM, FM, PHONO or Tape playback	CAUSE	REMEDY
Nothing is displayed	a) Power cord not plugged in. b) Poor connection at wall outlet.	a) Check plug contact. b) Check outlet using a lamp or other appliance (outlet may be controlled by a wall switch).
No sound from left or right.	a) Speaker cords disconnected. b) SPEAKERS switched off. c) PRESET VOL control fully counterclockwise. d) TAPE MONITOR key A or B pushed.	a) Check speaker connections b) Check SPEAKERS keys c) Adjust volume. d) Push the SOURCE key
Sound from left or right, but not both.	a) Poor speaker connections b) Defective speaker. c) BALANCE set to one side extreme.	a) Check connections at both ends of speaker cord b) Reverse speakers, if problem stays with speaker have speaker checked c) Check setting of BALANCE control
Occurs during AM reception only	CAUSE	REMEDY
Continuous low-frequency buzz. Most noticeable on weak stations or at night.	Interference from fluorescent lamps, lamp dimmers, other appliances.	Turn off fluorescent lamps or lamp dimmer. Try AM outdoor antenna and good ground at GND connections. This problem may be impossible to eliminate altogether
High-frequency whistle especially at night	a) Interference from TV set b) Beat from adjacent AM station	a) Turn off TV set, if problem disappears try relocating TV set. b) Impossible to eliminate, but try graphic equalizer compensator.
Intermittent buzz or cracking sound.	a) Lightning b) Fluorescent lamps starting c) Appliance or furnace starting	a) No remedy. b) Try reversing AC plug c) Try reversing AC plug
Occurs During FM Reception only	CAUSE	REMEDY
Continuous hiss or buzzing.	Weak antenna signal.	Install outdoor antenna
Occasional sharp rhythmic cracking noise.	Ignition interference from autos	Locate outdoor antenna as far from road as possible, use coaxial cable
No sound on weak stations	Signal too weak to overcome muting	Set MODE switch to MONO Install outdoor antenna and orient for highest number of LED SIGNAL indicator
PHONO Playback only	CAUSE	REMEDY
No sound from both or one speaker.	Turntable output disconnected	Check phono cables
Loud hum drowns out sound.	Poor ground connection at phono-cable connections.	Check phono plugs, particularly outer shell connections
Howling noise at maximum volume settings	Acoustic pickup from speaker	Increase distance between speaker and turntable. Place the turntable where no vibration occurs.
Other operations	CAUSE	REMEDY
SUN — SAT — — Flashes in the timer display.	Current started flowing again after a power failure or power plug connected again.	Reset the time
Timer programs not executed.	THROUGH function is used	Press the keys other than THROUGH and POWER to release it
All the stored programs was cleared.	A power failure occurred or power plug disconnected.	Store programs again

